



1.225V MICROPOWER VOLTAGE REFERENCE

- 1.225V TYP OUTPUT VOLTAGE
- ULTRA LOW OPERATING CURRENT : 40 μ A typ.
- HIGH PRECISION @ 25°C
 - +/-2% (Standard version)
 - +/-1% (A grade)
 - +/-0.5% (B grade)
- HIGH STABILITY WHEN USED WITH CAPACITIVE LOADS
- WIDE TEMPERATURE RANGE : -40 to +85°C
- T092 & SOT23-3 PACKAGES

DESCRIPTION

The TS821 is a micropower integrated circuit which is a high stability, two terminals, band gap reference providing a stable output voltage over the industrial temperature range (-40 to +85°C). The minimum operating current is guaranteed at 50 μ A over the full operating temperature range.

APPLICATIONS

- Computers
- Instrumentation
- Battery chargers
- Switch Mode Power Supply
- Battery operated equipments

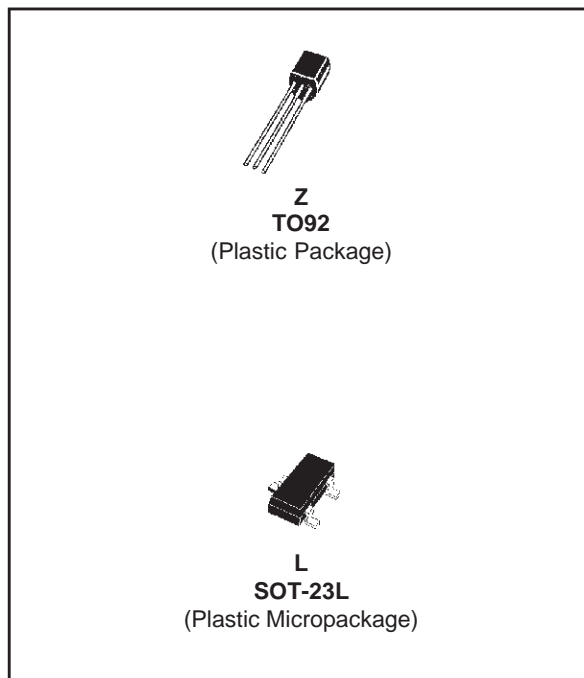

ORDER CODES

Precision	TO92	SOT23-3	SOT23 Marking
2%	TS821IZ	TS821ILT	L213
1%	TS821AIZ	TS821AILT	L212
0.5%	TS821BIZ	TS821BILT	L211

Single temperature range : -40 to +85°C

PIN CONNECTIONS (top view)

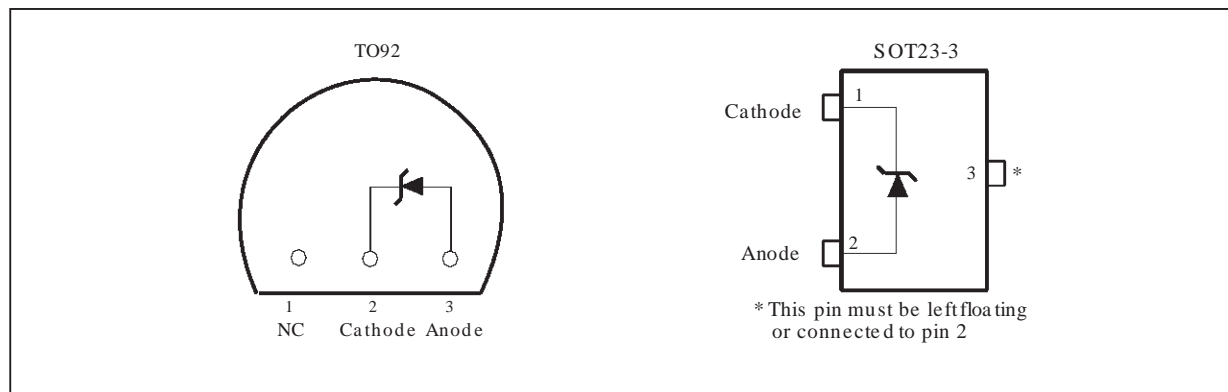

ABSOLUTE MAXIMUM RATINGS

Symbol	Parameter	Value	Unit
I_k	Reverse Breakdown Current	20	mA
I_f	Forward Current	10	mA
P_d	Power Dissipation	SOT23-3 TO92 360 625	mW
T_{oper}	Operating Free Air Temperature Range	-40 to +85	°C
T_{stg}	Storage Temperature	-65 to +150	°C

Note : P_d has been calculated with $T_{amb} = 25^\circ\text{C}$ and $T_j = 125^\circ\text{C}$ and
 $R_{thja} = 200^\circ\text{C/W}$ for TO92 package
 $R_{thja} = 340^\circ\text{C/W}$ for SOT23 package

OPERATING CONDITIONS

Symbol	Parameter	Value	Unit
I_{min}	Minimum Operating Current	45	μA
I_{max}	Maximum Operating Current	12	mA

ELECTRICAL CHARACTERISTICS

TS821 (2% Precision)

$T_{amb} = 25^\circ\text{C}$ (unless otherwise specified)

Symbol	Parameter	Test Condition	Min.	Typ.	Max.	Unit
V_k	Reverse Breakdown Voltage	$I_k = 100\mu\text{A} @ T_{amb} = 25^\circ\text{C}$	1.200	1.225	1.250	V
	Reverse Breakdown Voltage Tolerance	$I_k = 100\mu\text{A} @ T_{amb} = 25^\circ\text{C}$ $-40^\circ\text{C} < T_{amb} < +85^\circ\text{C}$	-25 -36		+25 +36	mV
I_{kmin}	Minimum Operating Current	$T_{amb} = 25^\circ\text{C}$		40	45	μA
		$-40^\circ\text{C} < T_{amb} < +85^\circ\text{C}$			50	μA
$\Delta V_{ref}/\Delta T$	Average Temperature Coefficient	$I_k = 100\mu\text{A}$			150	ppm/°C
$\Delta V_k/\Delta I_k$	Reverse Breakdown Voltage Change with Operating Current Change	$I_{kmin} < I_k < 1\text{mA} @ T_{amb} = 25^\circ\text{C}$ $-40^\circ\text{C} < T_{amb} < +85^\circ\text{C}$		0.3	0.7 1	mV
		$1\text{mA} < I_k < 12\text{mA} @ T_{amb} = 25^\circ\text{C}$ $-40^\circ\text{C} < T_{amb} < +85^\circ\text{C}$		2.5	5 7	mV
R_{ka}	Static Impedance	$\Delta I_k = 45\mu\text{A}$ to 1mA		0.25	0.5	Ω
K_{vh}	Long Term Stability	$I_k = 100\mu\text{A}$, $t = 1000\text{hrs}$ $T_{amb} = 25^\circ\text{C}$		120		ppm
en	Wideband Noise	$I_k = 100\mu\text{A}$ $10\text{Hz} < f < 10\text{kHz}$		200		$\text{nV}\sqrt{\text{Hz}}$

ELECTRICAL CHARACTERISTICS**TS821A (1% Precision)** $T_{amb} = 25^{\circ}\text{C}$ (unless otherwise specified)

Symbol	Parameter	Test Condition	Min.	Typ.	Max.	Unit
V_k	Reverse Breakdown Voltage	$I_k = 100\mu\text{A} @ T_{amb} = 25^{\circ}\text{C}$	1.213	1.225	1.237	V
	Reverse Breakdown Voltage Tolerance	$I_k = 100\mu\text{A} @ T_{amb} = 25^{\circ}\text{C}$ $-40^{\circ}\text{C} < T_{amb} < +85^{\circ}\text{C}$	-12 -24		+12 +24	mV
I_{kmin}	Minimum Operating Current	$T_{amb} = 25^{\circ}\text{C}$		40	45	μA
		$-40^{\circ}\text{C} < T_{amb} < +85^{\circ}\text{C}$			50	μA
$\Delta V_{ref}/\Delta T$	Average Temperature Coefficient	$I_k = 100\mu\text{A}$			150	ppm/ $^{\circ}\text{C}$
$\Delta V_k/\Delta I_k$	Reverse Breakdown Voltage Change with Operating Current Change	$I_{kmin} < I_k < 1\text{mA} @ T_{amb} = 25^{\circ}\text{C}$ $-40^{\circ}\text{C} < T_{amb} < +85^{\circ}\text{C}$		0.3	0.7 1	mV
		$1\text{mA} < I_k < 12\text{mA} @ T_{amb} = 25^{\circ}\text{C}$ $-40^{\circ}\text{C} < T_{amb} < +85^{\circ}\text{C}$		2.5	5 7	mV
R_{ka}	Static Impedance	$\Delta I_k = 45\mu\text{A}$ to 1mA		0.25	0.5	Ω
K_{vh}	Long Term Stability	$I_k = 100\mu\text{A}$, $t = 1000\text{hrs}$ $T_{amb} = 25^{\circ}\text{C}$		120		ppm/kHr
en	Wideband Noise	$I_k = 100\mu\text{A}$ $10\text{Hz} < f < 10\text{kHz}$		200		$\text{nV}/\sqrt{\text{Hz}}$

ELECTRICAL CHARACTERISTICS**TS821B (0.5% Precision)** $T_{amb} = 25^{\circ}\text{C}$ (unless otherwise specified)

Symbol	Parameter	Test Condition	Min.	Typ.	Max.	Unit
V_k	Reverse Breakdown Voltage	$I_k = 100\mu\text{A} @ T_{amb} = 25^{\circ}\text{C}$	1.219	1.225	1.231	V
	Reverse Breakdown Voltage Tolerance	$I_k = 100\mu\text{A} @ T_{amb} = 25^{\circ}\text{C}$ $-40^{\circ}\text{C} < T_{amb} < +85^{\circ}\text{C}$	-6 -14		+6 +14	mV
I_{kmin}	Minimum Operating Current	$T_{amb} = 25^{\circ}\text{C}$		40	45	μA
		$-40^{\circ}\text{C} < T_{amb} < +85^{\circ}\text{C}$			50	μA
$\Delta V_{ref}/\Delta T$	Average Temperature Coefficient	$I_k = 100\mu\text{A}$			120	ppm/ $^{\circ}\text{C}$
$\Delta V_k/\Delta I_k$	Reverse Breakdown Voltage Change with Operating Current Change	$I_{kmin} < I_k < 1\text{mA} @ T_{amb} = 25^{\circ}\text{C}$ $-40^{\circ}\text{C} < T_{amb} < +85^{\circ}\text{C}$		0.3	0.7 1	mV
		$1\text{mA} < I_k < 12\text{mA} @ T_{amb} = 25^{\circ}\text{C}$ $-40^{\circ}\text{C} < T_{amb} < +85^{\circ}\text{C}$		2.5	5 7	mV
R_{ka}	Static Impedance	$\Delta I_k = 45\mu\text{A}$ to 1mA		0.25	0.5	Ω
K_{vh}	Long Term Stability	$I_k = 100\mu\text{A}$, $t = 1000\text{hrs}$ $T_{amb} = 25^{\circ}\text{C}$		120		ppm
en	Wideband Noise	$I_k = 100\mu\text{A}$ $10\text{Hz} < f < 10\text{kHz}$		200		$\text{nV}/\sqrt{\text{Hz}}$

Reference Voltage versus Cathode Current

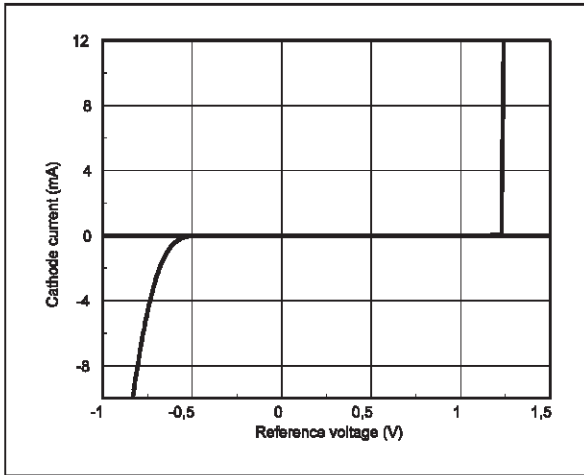

Reference Voltage versus Cathode Current

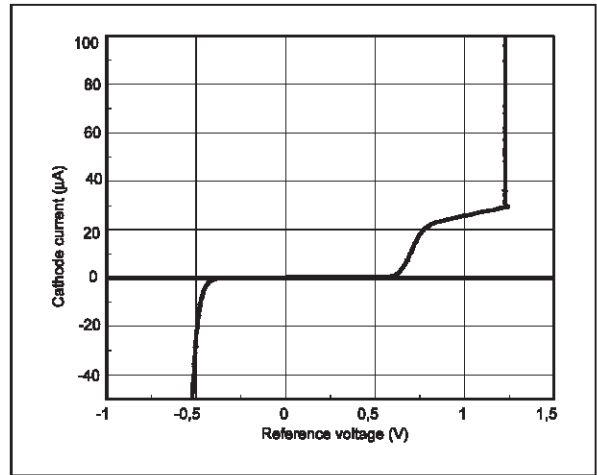

Test Circuit

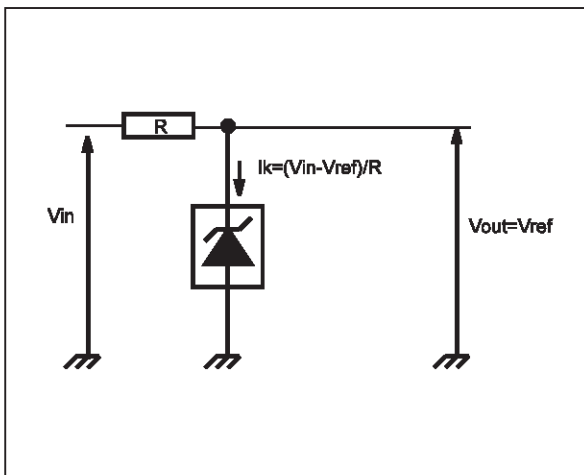

Reference Voltage versus Temperature

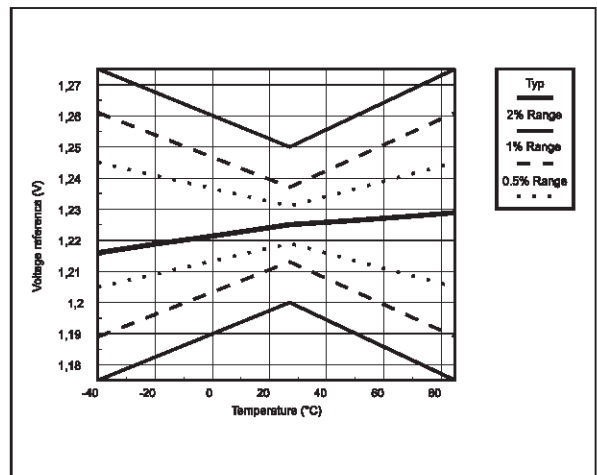

Dynamic Impedance versus Temperature

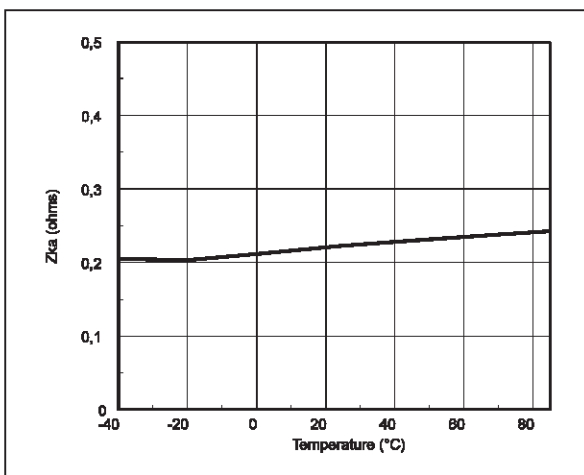

Noise Voltage versus Frequency

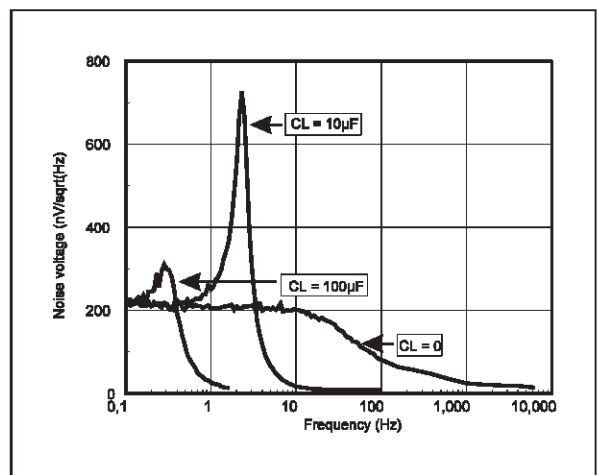

Pulse Response for $I_k = 100\text{mA}$

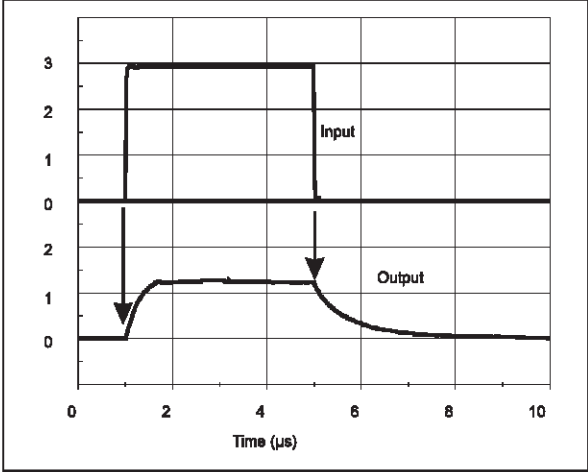

Test Circuit for Pulse Response at $I_k = 100\text{mA}$

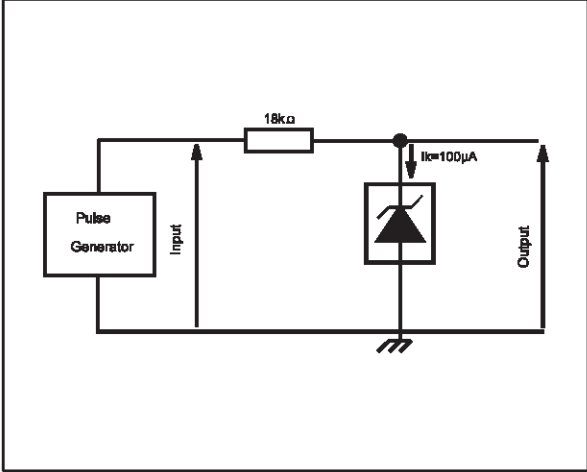

Pulse Response for $I_k = 1\text{mA}$

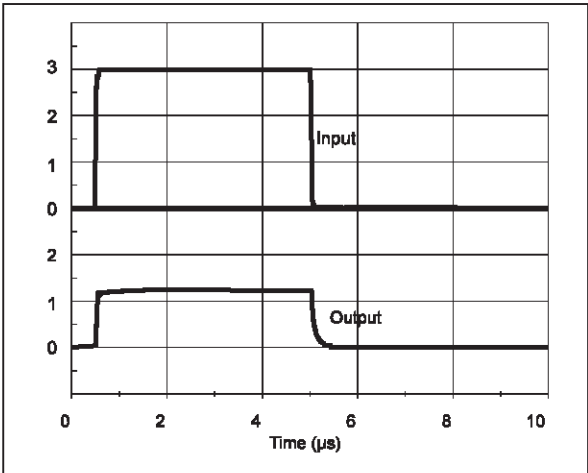

Test Circuit for Pulse Response at $I_k = 1\text{mA}$

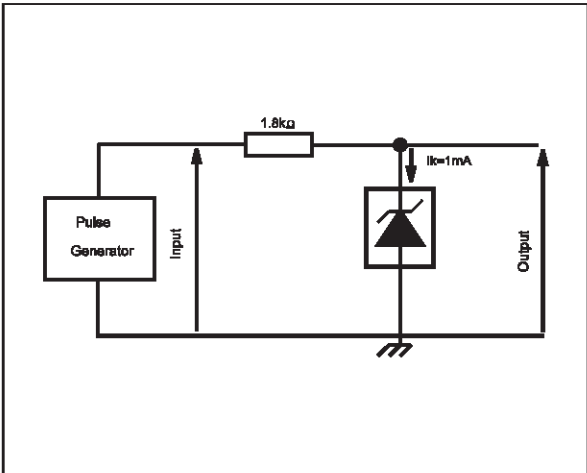

PACKAGE MECHANICAL DATA
 3 PINS - PLASTIC PACKAGE TO92

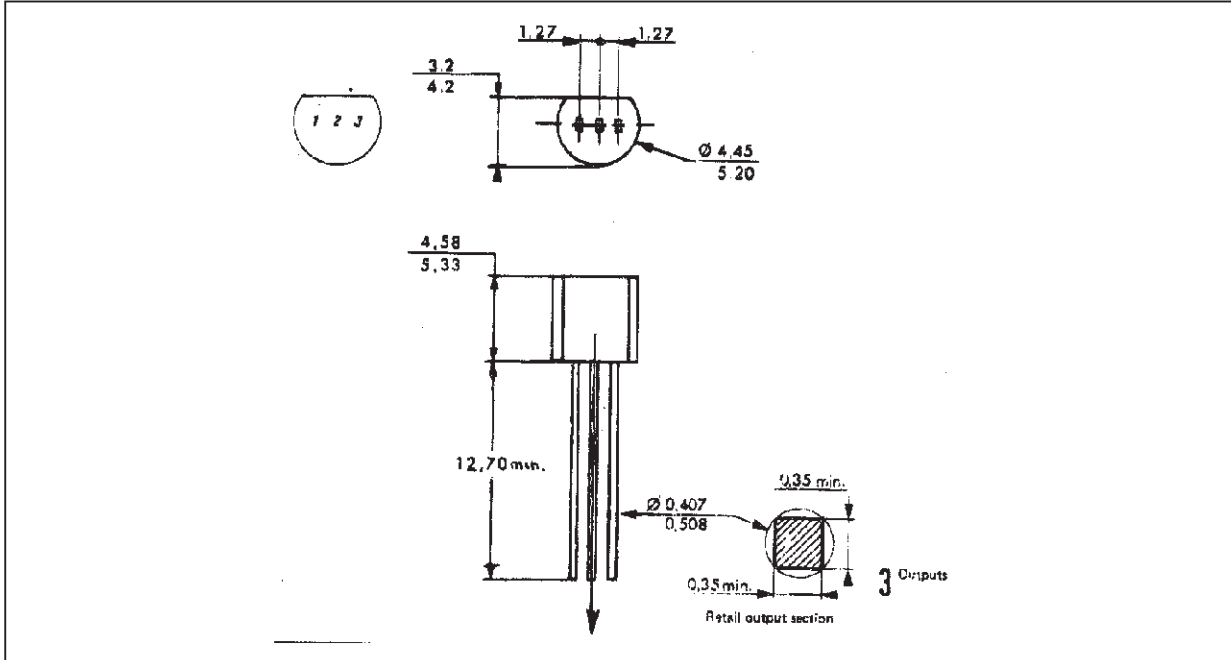

Dim.	Millimeters			Inches		
	Min.	Typ.	Max.	Min.	Typ.	Max.
L		1.27			0.05	
B	3.2	3.7	4.2	0.126	0.1457	0.1654
O1	4.45	5.00	5.2	0.1752	0.1969	0.2047
C	4.58	5.03	5.33	0.1803	0.198	0.2098
K	12.7			0.5		
O2	0.407	0.5	0.508	0.016	0.0197	0.02
a	0.35			0.0138		

PACKAGE MECHANICAL DATA
3 PINS - TINY PACKAGE (SOT23)

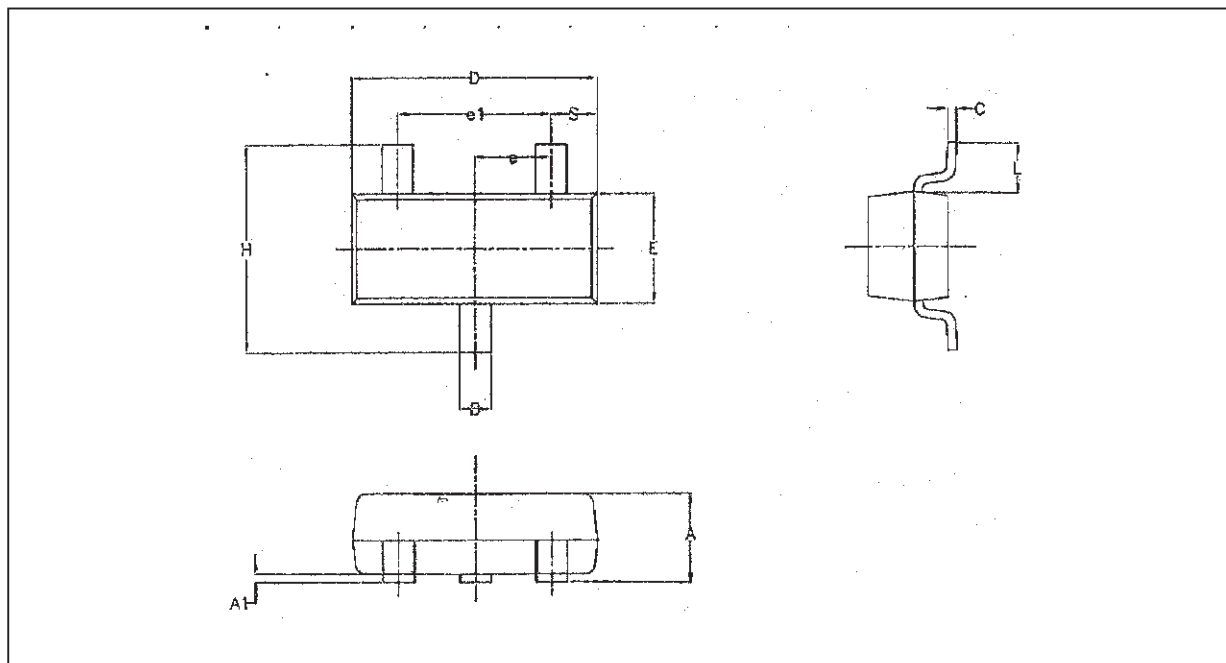

Dim.	Millimeters			Inches		
	Min.	Typ.	Max.	Min.	Typ.	Max.
A	0.890		1.120	0.035		0.044
A1	0.010		0.100	0.0004		0.004
A2	0.880	0.950	1.020		0.037	0.040
b	0.300		0.500	0.012		0.020
c	0.080		0.200	0.003		0.008
D	2.800	2.900	3.040	0.110	0.114	0.120
E	2.100		2.640	0.083		0.104
E1	1.200	1.300	1.400	0.047	0.051	0.055
e		0.950			0.037	
e1		1.900			0.075	
L	0.400	0.500	0.600	0.016	0.020	0.024
L1		0.540			0.021	
k	0°		8°			

Information furnished is believed to be accurate and reliable. However, STMicroelectronics assumes no responsibility for the consequences of use of such information nor for any infringement of patents or other rights of third parties which may result from its use. No license is granted by implication or otherwise under any patent or patent rights of STMicroelectronics. Specifications mentioned in this publication are subject to change without notice. This publication supersedes and replaces all information previously supplied. STMicroelectronics products are not authorized for use as critical components in life support devices or systems without express written approval of STMicroelectronics.

© The ST logo is a trademark of STMicroelectronics

© 2000 STMicroelectronics – Printed in Italy – All Rights Reserved

STMicroelectronics GROUP OF COMPANIES

Australia - Brazil - China - Finland - France - Germany - Hong Kong - India - Italy - Japan - Malaysia - Malta - Morocco
Singapore - Spain - Sweden - Switzerland - United Kingdom - U.S.A.

© <http://www.st.com>